

ONLEVEL

1

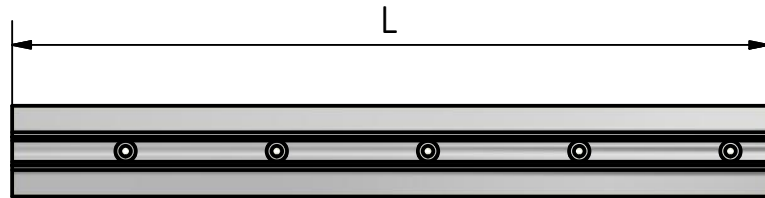

2

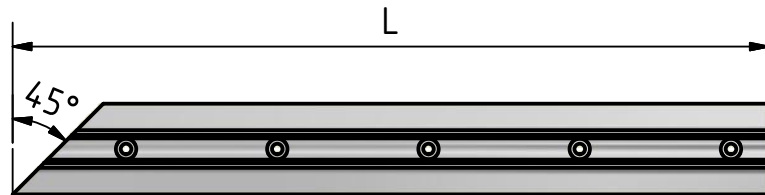

3

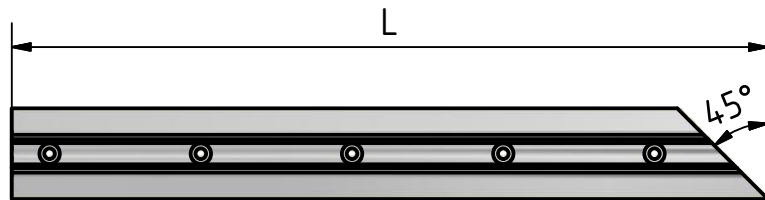

4

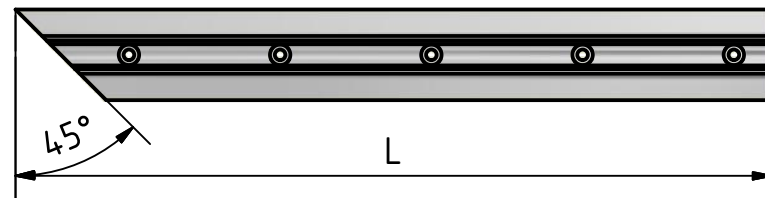

5

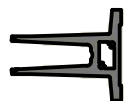
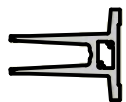
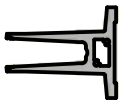
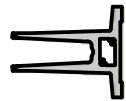
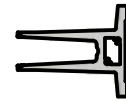
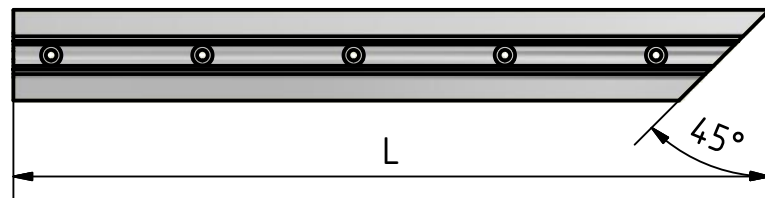

TL-4010

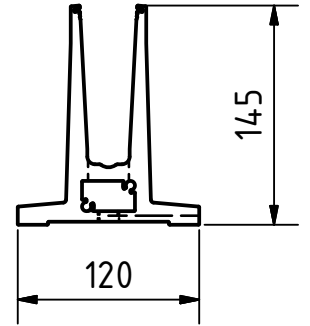

Profile no.	model no.	L (max. 5000mm)	Qty
1		mm	
2		mm	
3		mm	
4		mm	
5		mm	
6		mm	
7		mm	
8		mm	
9		mm	
10		mm	
11		mm	
12		mm	
13		mm	
14		mm	
15		mm	

Customer	
Order	
Project	
date	